

–weishaupt–

product

Information on compact oil burners



Digital Combustion Technology

Weishaupt oil burners WL10 to WL40

Hot for quality

Our motivation is technological progress, which has been driving us for more than 50 years to set new standards for the combustion industry.

Weishaupt's own research and development centre constantly works on both new developments and the optimization of existing products.

It is our goal and our responsibility to go above and beyond current legislative requirements in developing combustion systems which generate less emissions, save more and more energy and in doing so combining ecology and economy in a practical manner.

Furthermore not only do we invest in research and technology but also we only use the best materials and utilize the most advance manufacturing tools.

It has been proven over a million times in the field that heating specialists and customers hold Weishaupt burners to be reliable, long lasting, environmentally friendly and technologically advanced. A fact also documented by numerous design and innovation prizes.

Over 600 burners are manufactured daily at our ultra-modern production facilities in Schwendi. Every single burner is subjected to mechanical and electrical function test. The combination of technology with an effective quality control system ensures Weishaupt's renowned reputation for quality.

A new burner is always an investment in the future. Cost needs to be well balanced against use, but the final deciding factors for long term success are quality, technology and safety. Choosing Weishaupt burners is therefore a safe investment in the future.



Ultra-modern research and production methods and rigorous quality control ensures the quality for which Weishaupt is renowned

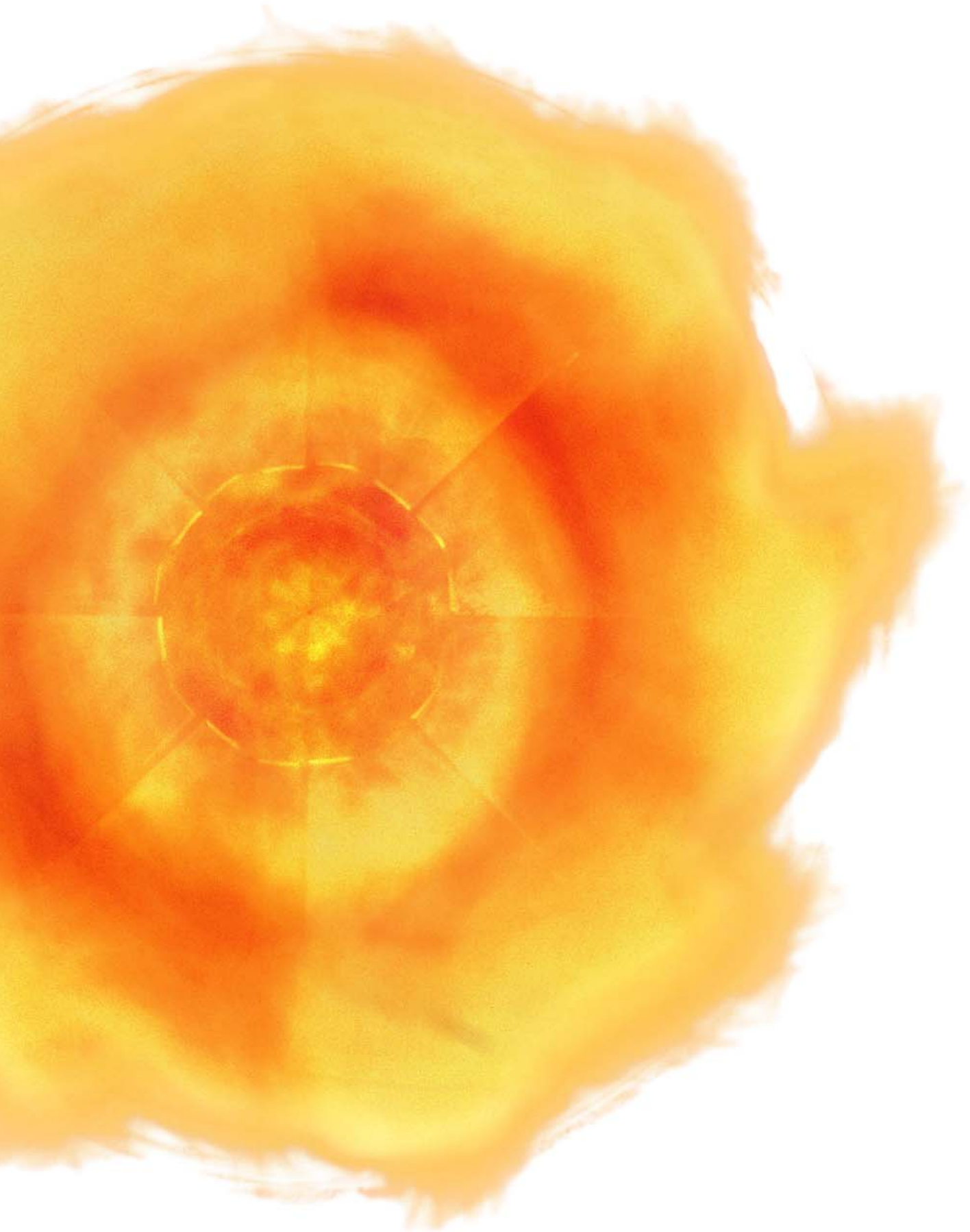



A hallmark of practical combustion technology

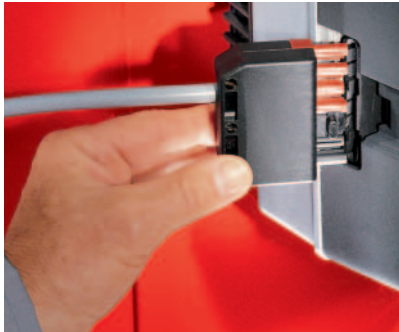

Coded plugs for safe electrical connection



All components are easily accessible



Simple commissioning and diagnosis

A safe investment in the future

Reliable and economical: The millionfold success of the Weishaupt compact burners is the result of orienting without compromise towards quality and the customer. The technology has been constantly developed and improved over decades.

The most advanced production methods and stringent quality checks of all products ensure Weishaupt's reputation for quality. You are making a safe investment in the future.

Broad capacity range

The broad capacity range of 120 to 1,900 MBTU/h makes the burners suitable for very wide range of heat exchangers.

Electronic ignition

The W-ZG 01 ignition unit used on all Weishaupt W burners is particularly energy efficient and extremely reliable.

Digital combustion management for safe and ease of use

Weishaupt is a pioneer in this field. Digital combustion management offers greater ease of use and simple servicing, even greater reliability in operation, and, last but not least, an extremely attractive price/performance ratio. Furthermore, this intelligent technology enables the burner to be integrated with complex automation systems.

Outstanding service

Weishaupt has an extensive sales and service network worldwide. Customer service is available around the clock. Optimal in-house training at Weishaupt ensures our service engineers are of the highest calibre.

Proven quality

All W series burners are in compliance with most North American and European applicable standards :

- UL std 296
- CSA B140.2.1-M90
- CSA B140.0-M87
- EN 267

Digital combustion management: safe and easy to use



All Weishaupt W series burners are equipped with digital combustion managers as standard, which control and monitor all burner functions. The result: Weishaupt burners are easy to use, precise and efficient.

The digital combustion managers also offer the possibility of communicating with other systems via an integrated eBUS port. This enables remote monitoring and operation of the burner.

The key points:

- Utilization of identical units for gas and oil burners simplifies commissioning and reduces the number of spares required.
- Non-interchangeable plug connections ensure the correct electrical connection of all components
- Electrical remote reset is possible
- Safety is ensured with the use of two microprocessors (reciprocal monitoring)
- Multi-coloured LED lamp to indicate burner operational stage and fault conditions (WL 10 and WL20)
- LCD display for commissioning and operating. The burner is setup directly via the operating and display unit (WL30 and WL40)
- Suitable for continuous operation of hot water boiler (controlled shutdown and restart every 24 hours)
- Suitable for steam boilers and hot air generators

System overview Digital combustion management	W-FM 10	W-FM 20
Combustion manager for intermittent operation	●	●
Flame sensor	QRB	QRB
Stepping motor Air	●	●
Single fuel operation	●	●
Removable control unit (max. distance)		30 ft (10 m)
eBUS interface	●	●
Available on burner models	WL 10-D WL 20-C two stage	WL30-C WL40-A two stage

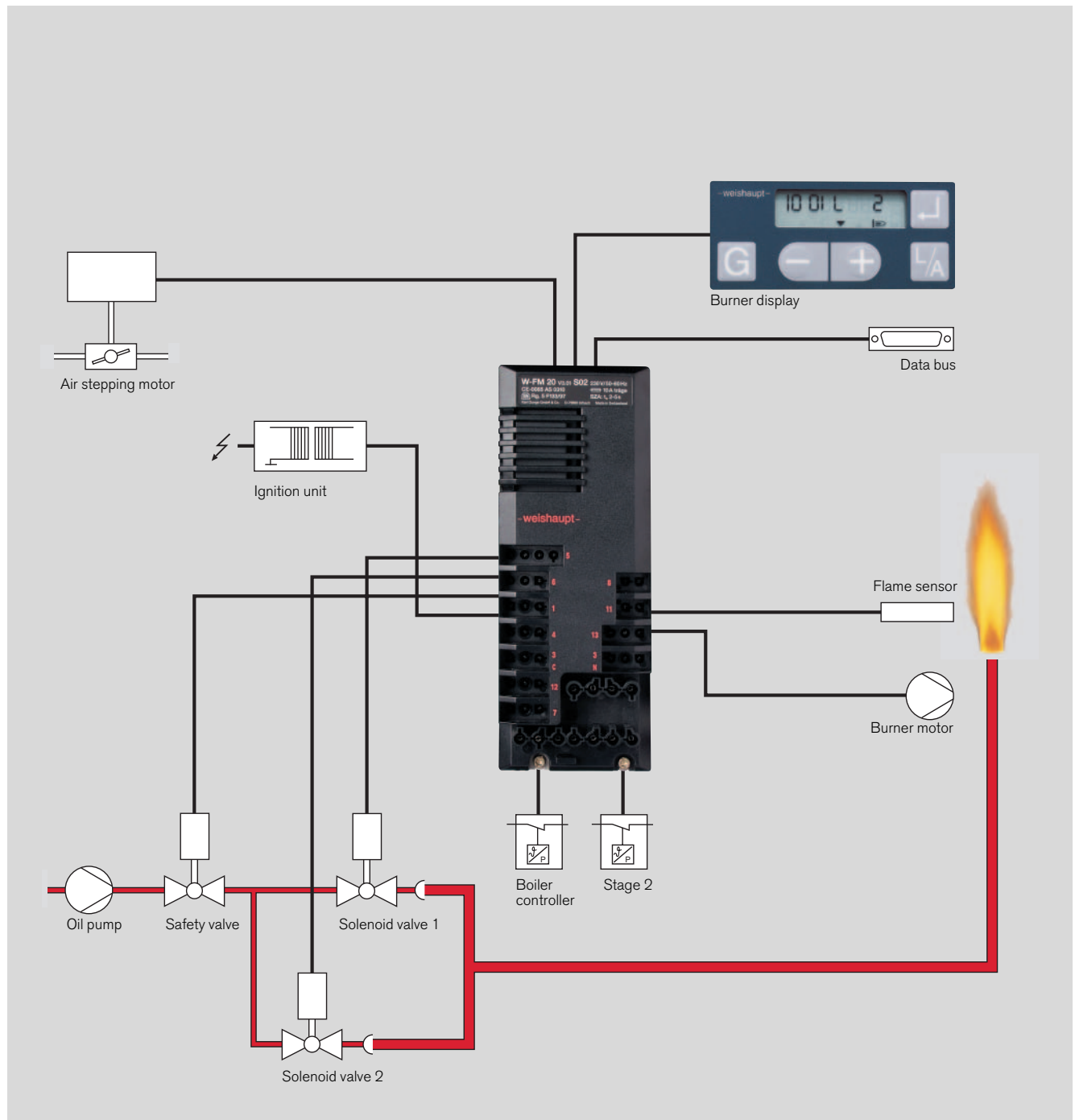

Example of digital combustion management on WL40

Trustworthy technology

Even the visual impression after removing the burner cover is convincing. All components are clearly arranged, the electrical connections are obvious and non-interchangeable. The technology makes a good impression because it is typical Weishaupt.

Compact construction

The WL burner's compact construction means they can be easily installed by one person. Commissioning costs have been reduced to a minimum.

Sound attenuated air inlet

The transverse fan is sound attenuated on the suction side. These burners therefore operate particularly quiet.

Electronically controlled air damper

The electronically controlled air damper closes at burner shutdown to prevent the cooling-down of the combustion chamber.

Sevicing position

A special bracket enables the burner to be put into a servicing position, which enabling easy access to the burner and mixing assembly.

Common platform

The common platform principle used with W burners simplifies the provision and storage of spare parts.

Diagnosis via laptop as an option

A special software package and connection cables are available for communication with the combustion manager. Combustion optimization and fault analysis can thus be carried out easily via a laptop computer.

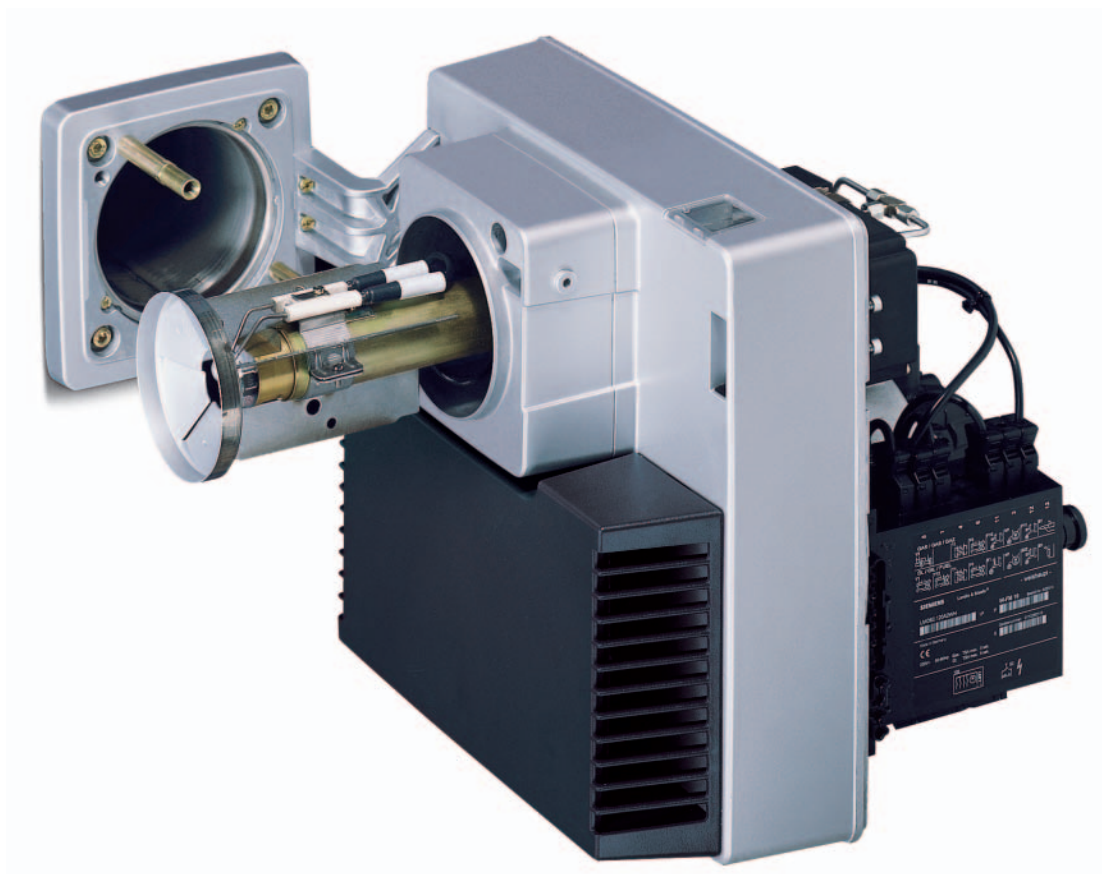

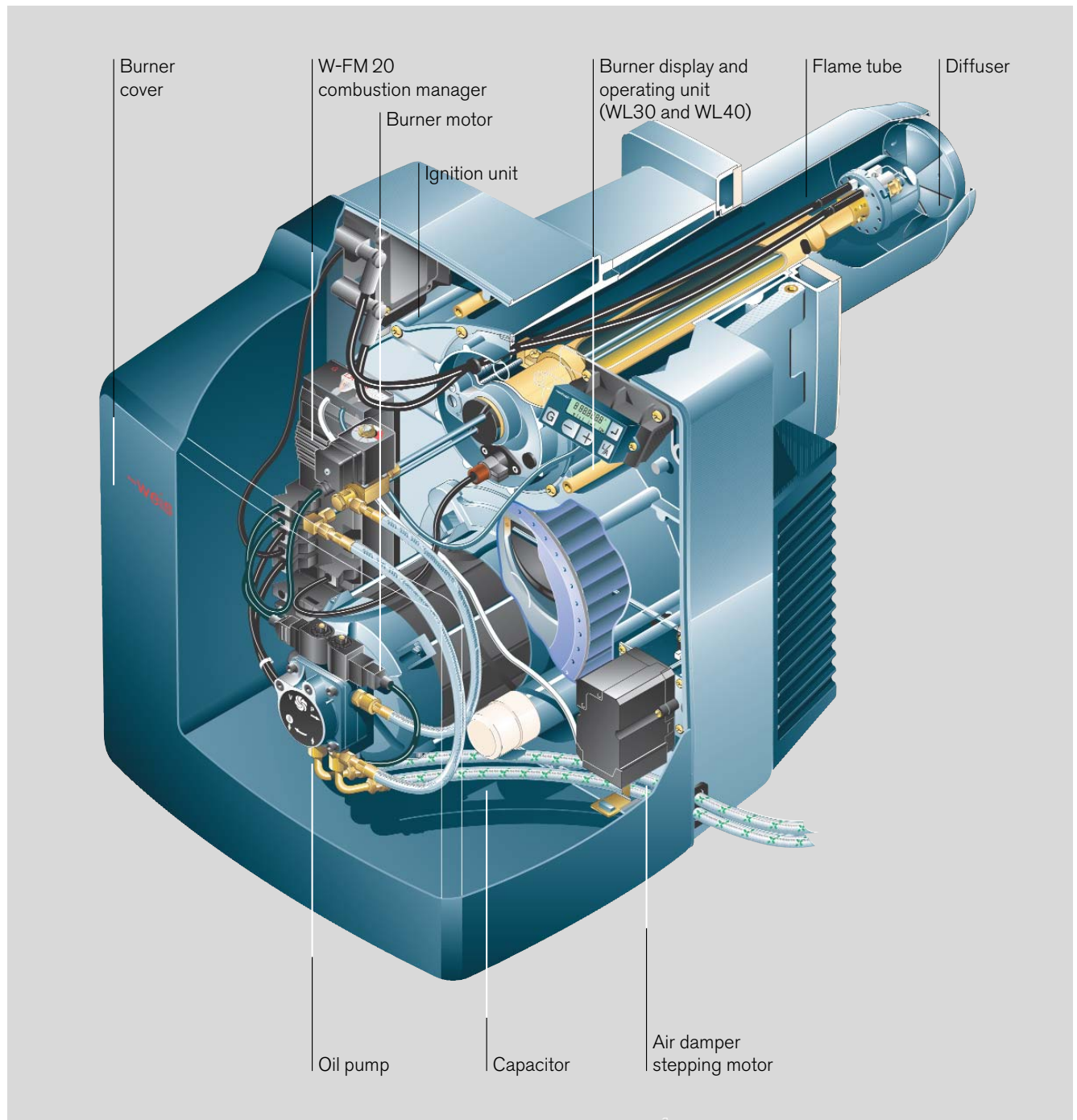

Example: WL40 with W-FM20 combustion manager

Burner capacities in relation to combustion chamber resistance

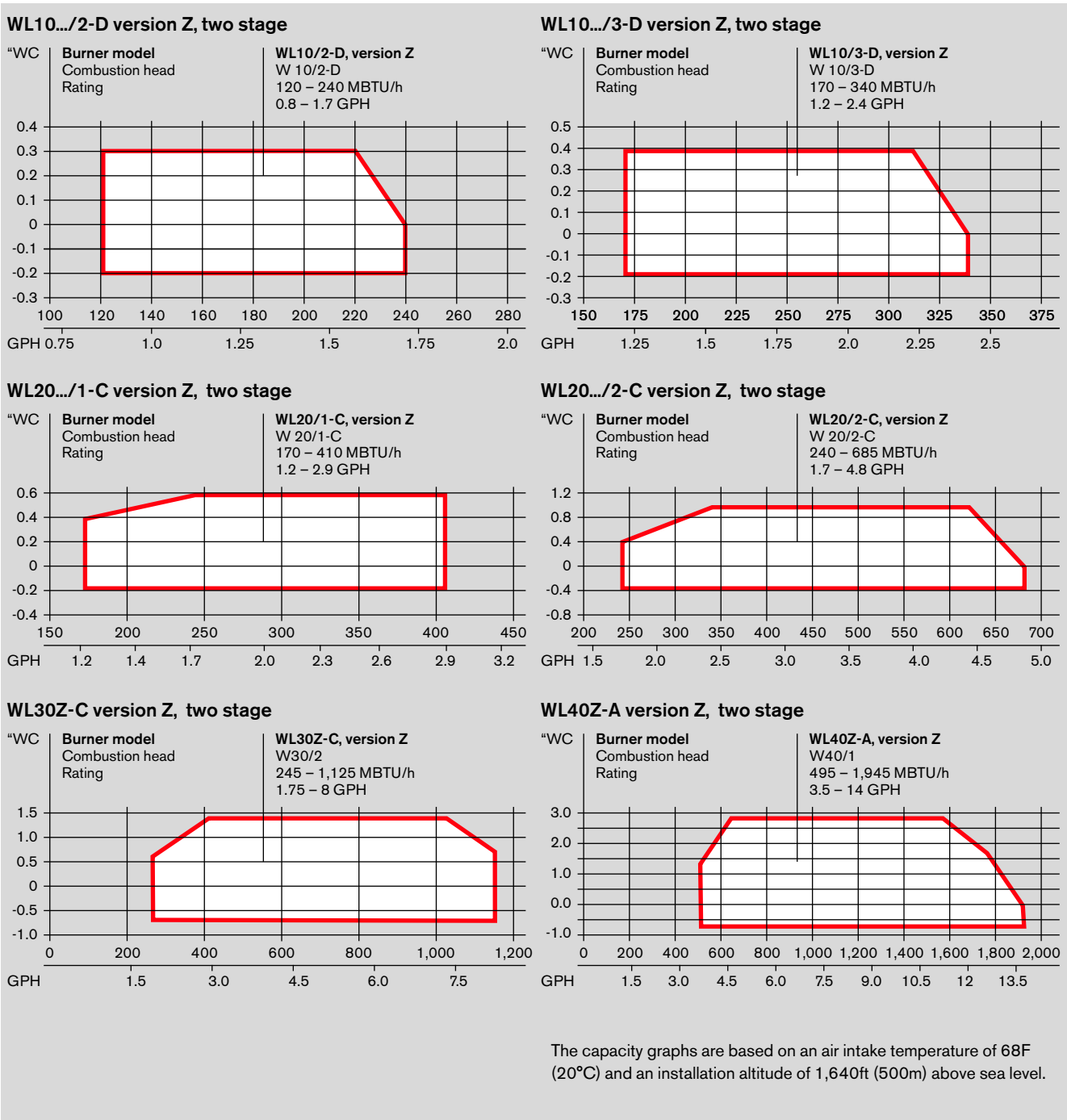

Model overview

Burner model	Version	Mode of operation	Capacity MBTU/hr	Weight lbs (kg)	Order No.
WL10					
WL 10/2-D	Z	two stage	120 - 240	31 (14)	232 123 24
WL 10/3-D	Z	two stage	170 - 340	31 (14)	233 110 24
WL20					
WL20/1-C	Z	two stage	170 - 410	44 (20)	232 216 34
WL20/2-C	Z	two stage	240 - 685	44 (20)	232 216 44
WL30					
WL30Z-C	Z	two stage	245 - 1,125	62 (28)	232 326 21
WL40					
WL40Z-A	Z	two stage	495 - 1,945	82 (37)	232 416 21

Nomenclature

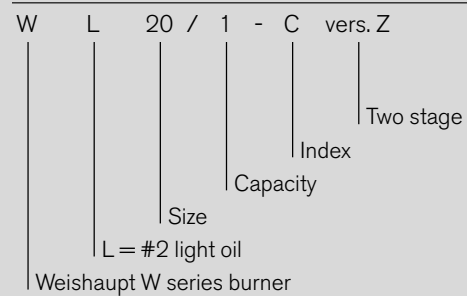

Technical data

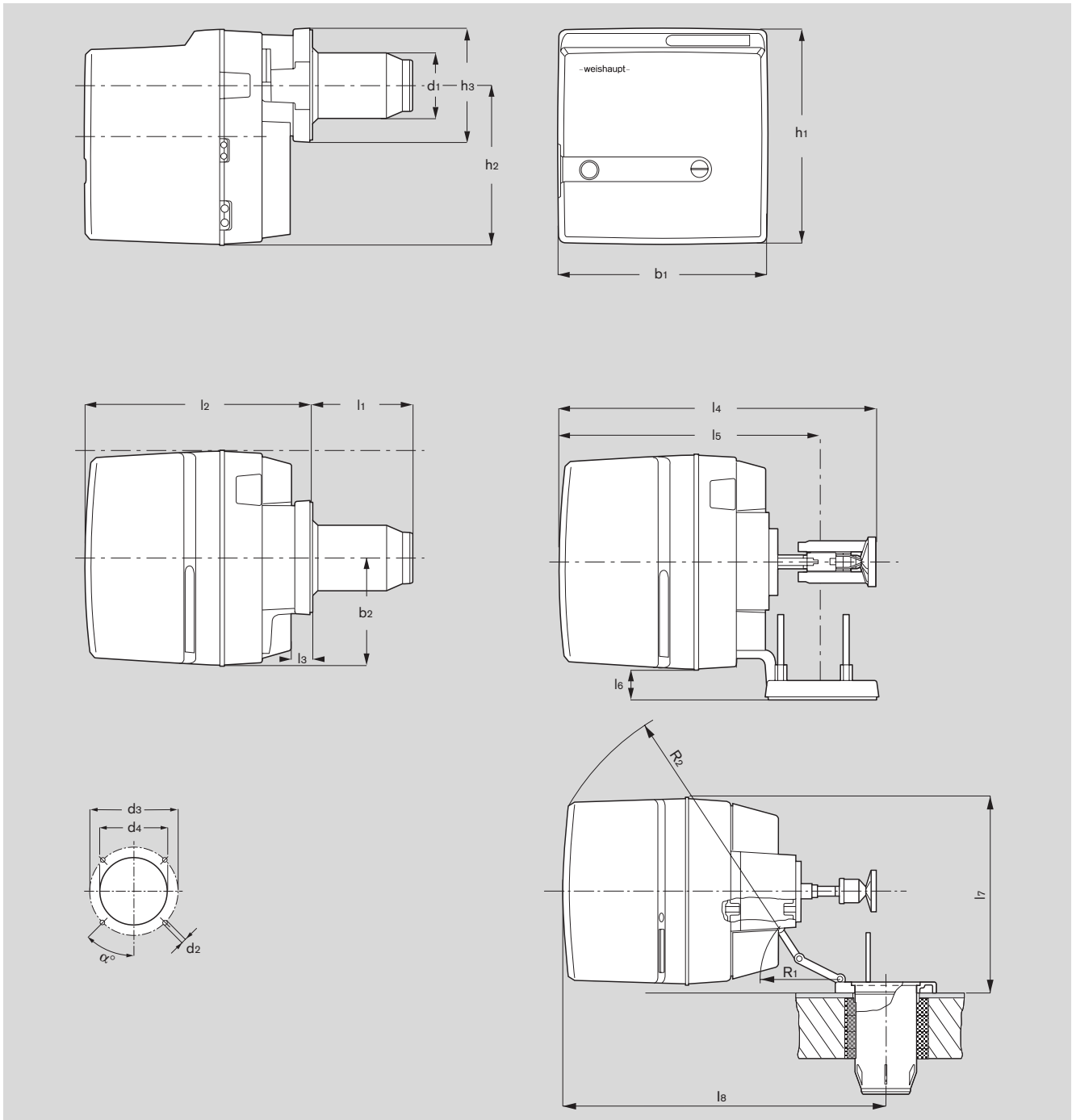

Burner dimensions

Burner model	Dimensions in inches and (mm)															
	l ₁	l ₂	l ₃	l ₄	l ₅	l ₆	l ₇	l ₈	b ₁	b ₂	b ₃	h ₁	h ₂	h ₃	h ₄	
WL10/2-D	5.4	13.6	1.3	18.7	15.7	2.0			13.0	6.5		13.9	10.6	6.5		
	137	345	32	476	398	51	–	–	330	165	–	353	270	165	–	
WL10/3-D	5.5	13.6	1.3	18.7	15.7	2.0			13.0	6.5		13.9	10.6	6.5		
	140	345	32	476	398	51	–	–	330	165	–	353	270	165	–	
WL20/1-C	5.7	15.5	1.2	20.7	17.1	2.9			14.1	7.0		14.8	11.2	7.2	7.2	
	144	393	31	525	434	73	–	–	358	179	–	376	285	182	183	
WL20/2-C	6.9	15.5	1.2	4.5	17.1	2.9			14.1	7.0		14.8	11.2	7.2	7.2	
	174	393	31	558	434	73	–	–	358	179	–	376	285	182	183	
WL30Z-C	6.7	18.9	1.6	1.2	23.6	2.4	18.1	23.6	16.5	8.9	3.9	18.1	13.5			
	169	480	40	30	600	62	460	600	420	226	100	460	342	–	–	
WL40Z-A	9.3	22.7	1.6	1.2	24.2	2.8	18.9	24.2	17.7	9.6	4.3	18.9	14.2			
	235	577	40	30	615	72	480	615	450	245	108	480	360	–	–	

Burner model	Dimensions in inches and (mm)									
	d ₁	d ₂	d ₃	d ₄	d ₅	d ₆	R ₁	R ₂	α°	
WL10/2-D	3.9	M8	5.9 – 6.7	4.3						
	99		150 – 170	110	–	–	–	–		
WL10/3-D	4.3	M8	5.9 – 6.7	4.3						
	108		150 – 170	110	–	–	–	–		
WL20/1-C	4.3	M8	6.7	5.1	4.8	5.9				
	108		170	130	123	150	–	–	–	
WL20/2-C	4.7	M8	6.7	5.1	4.8	5.9				
	120		170	130	123	150	–	–	–	
WL30Z-C	5.0	M8	6.7 – 7.3	5.1			6.2	19.3	45°	
	127		170 – 186	130	–	–	158	490		
WL40Z-A	5.9	M10	7.3 – 7.9	6.3			7.3	22.4	45°	
	151		186 – 200	160	–	–	185	570		

That is not a Facade. That is Reliability.

Weishaupt is Reliability.

The family business in Schwendi was established by Max Weishaupt in 1932. Represented in 55 countries by branch offices and subsidiaries Weishaupt is now international leader in the areas of combustion technology and heating applications.

Trustworthy, quality, customer service, innovation and experience are values on which the pioneer Max Weishaupt built his company. All this combined in a word is reliability. Therefore stands Weishaupt today.



Weishaupt Forum in Schwendi



- weishaupt -

Weishaupt Corporation
6280 Danville Road
Mississauga, ON L5T 2H7, Canada
Ph: (905) 564 0946
Fax: (905) 564 0949
www.weishaupt-corp.com

Weishaupt America Inc.
2587 Millenium Drive, Unit A
Elgin, IL 60124, USA
Ph: (847) 531 5800
Fax: (847) 531 5855
www.weishaupt-america.com

Print No. 83205416, December 2008
Printed in Germany. All rights reserved.



Regular maintenance reduces heating costs and environmental pollution. Only a properly adjusted burner can save energy and be environmentally friendly. Behind each Weishaupt burner stands the whole Weishaupt customer service organization. The outstanding efforts made in maintenance and service justify the enormous trust placed in Weishaupt's burners, for at Weishaupt, product and customer service belong together.

Weishaupt customer service is there for you all year round. Whenever you need help, be it the supply of spare parts, technical advice or a site visit. We are there when you need us.